



SBL.01.084.10000/B
SBL.01.084.10000/W
Revision: 02

Schutzbügel HONDA HONDA XRV 750 Africa Twin Crashbar HONDA HONDA XRV 750 Africa Twin

Montagehinweise

Alle vom Motorrad gelösten Schrauben sind gemäß Herstellerangaben wieder zu montieren, oder mit von SW-MOTECH gelieferten Schrauben zu ersetzen. Falls nicht anderweitig definiert, diese Schrauben nach Tabelle anziehen.

M8	23 Nm
M10	46 Nm

Gegebenenfalls Schrauben mit flüssiger Schraubensicherung einkleben.

Prüfen Sie nach 50 km alle Verbindungen auf festen Sitz.

SW-MOTECH GmbH & Co. KG
Ernteweg 8/10
35282 Rauschenberg
Germany

Tel. +49 (0) 64 25/8 16 8-00
Fax +49 (0) 64 25/8 16 8-10

info@sw-motech.com
www.sw-motech.com

Mounting Instructions

SW-MOTECH products should be installed by a qualified, experienced motorcycle technician. If you are unsure of your ability to properly install a product, please have the product installed by your local motorcycle dealer. SW-MOTECH takes no responsibility for damages caused by improper installation.

All screws, bolts and nuts, including all replacement hardware provided by SW-MOTECH, should be tightened to the torque specified in the OEM maintenance manual for your motorcycle. If no torque specifications are provided in the OEM maintenance manual, the following torques may be used:

M8	23 Nm
M10	46 Nm

All screws, bolts and nuts should be checked after driving the first 50 km to ensure that all are tightened to the proper torque.

Medium strength liquid thread-locker (i.e., "Locktite") should be used to secure all screws, bolts and nuts.

1 **Schutzbügel**
Crashbar

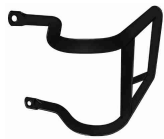

schwarz/weiß
SBL.01.084.901/902
Anzahl/ Pcs. 2 (L/R)

2 **Anschraubplatte**
Mounting Plate



SBL.01.084.002
Anzahl/ Pcs. 1

5 **Bügelschraube**
U-Bolt



BUS.00.08.030.060.01
Anzahl/ Pcs. 2

7 **Innensechskantschraube**
Hexagon Socket Screw



M10 x 260 DIN 912
Anzahl/ Pcs. 1

3 **Anschraubplatte**
Mounting Plate

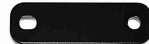

SBL.01.031.002
Anzahl/ Pcs. 1

6 **Bügelschraube**
U-Bolt



SBL.01.031.001
Anzahl/ Pcs. 1

8 **Unterlegscheibe**
Washer



A 10,5 DIN 125
Anzahl/ Pcs. 1

4 **Mutter mit Bund,**
selbstsichernd
Lock Nut with Flange



M8 DIN 6927
Anzahl/ Pcs. 6

9 **Mutter mit Bund,**
selbstsichernd
Lock Nut with Flange



M10 DIN 6927
Anzahl/ Pcs. 1

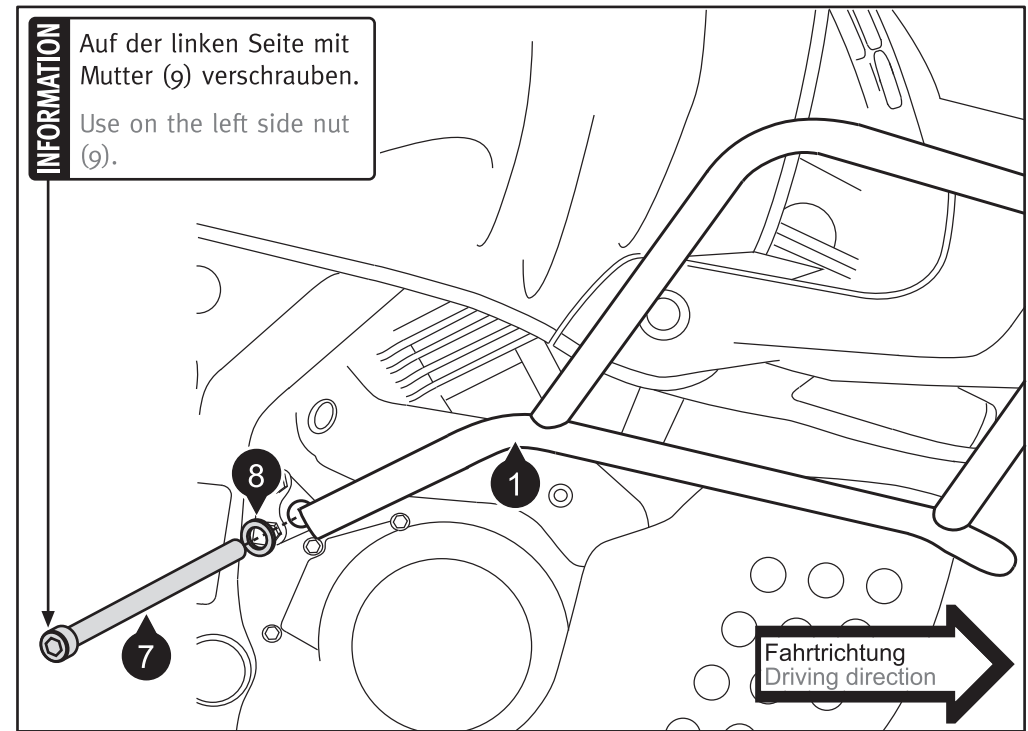
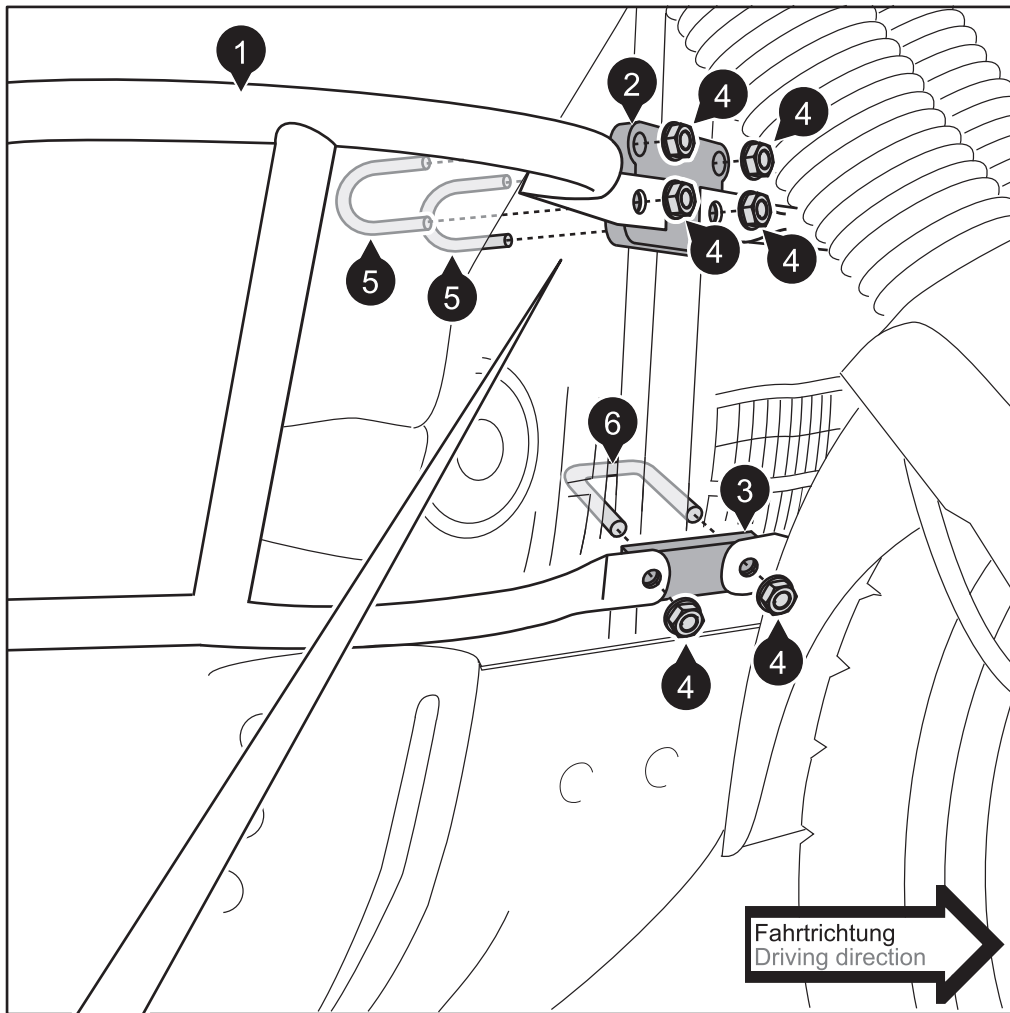

INFORMATION
 Auf der linken Seite mit Mutter (9) verschrauben.
 Use on the left side nut (9).



INFORMATION
 Achtung: Achten Sie bei der Montage der oberen Anschraubplatte (2) auf deren korrekte Ausrichtung (siehe Abbildung), da es sonst zu Schäden am Kühlersystem kommen kann.
 Attention: When attaching of the upper mounting plate (2) make sure the part is aligned correctly as shown. If the part is upside-down it is possible to damage the radiator system.

